



17 The Boulevard
Te Rapa, Hamilton
New Zealand

Ph: 07 849 3514
Email: office@abe.co.nz
Web: www.abe.co.nz



A close-up photograph of a metal surface, likely a component of a resistance spot welding machine. The surface is a reddish-brown color. In the center, there is a prominent red diamond-shaped mark. To the left, there is a yellow diamond-shaped mark. Above the red mark, there is some faint, illegible text. The background is dark and out of focus.

RESISTANCE SPOT WELDING

TABLE OF CONTENTS

INVERTASPOT GT AUTOMATIC	37
VAS 6545A	38
C-Trafogun GT-V6	39
C-Arms	40
Electrode Sets C-Trafogun	41
Electrodes	43
x-Trafogun GT-V6	44
Electrode sets X-Trafogun	45
Electrode caps	46
Airpuller AP95	47
Spot welding gun PSP - GT	48
Accessories PSP - GT	49
Accessories for InvertaSpot GT AUTOMATIC	51

Version	Voltage	Item no.
WS version	400 V	471002
WS version	200 V	473002
WS version CN	400 V	471007
VAS 6545A	400 V	932160
VAS 6545A	200 V	932131
VAS 6545A version UL	200 V	932163
VAS 6545A version CN	400 V	932167
BMW version	400 V	BMW9500735
BMW version	200 V	BMW9500839
BMW version Active Cooling	400 V	BMW9500696
Citroën version	400 V	471002
Citroën version	200 V	473002
Ferrari version	400 V	471025
Ford version	400 V	932710
Ford version	200 V	932711
GM version	400 V	471002
GM version	200 V	473002
Honda version	400 V	933710
Honda version	200 V	933711
Hyundai version	400 V	471002
Hyundai version	200 V	473002
Jaguar version	400 V	471002
Jaguar version	200 V	473002
Mazda version	400 V	471002
Mazda version	200 V	473002
Mercedes-Benz version	400 V	932436
Mercedes-Benz version	200 V	932437
Mercedes-Benz version CN	400 V	471023
Opel version	400 V	932182
Opel version	200 V	932183
Peugeot version	400 V	471002
Peugeot version	200 V	473002
Renault version	400 V	471002
Renault version	200 V	473002
Tesla version	400 V	960750
Tesla version	200 V	960753
Tesla version UL	200 V	471019
Tesla version CN	400 V	960752
Vauxhall version	400 V	932182
Vauxhall version	200 V	932183
Huk-Coburg version	400 V	471031
Innovation Group version	400 V	471030

The scope of delivery is different for all versions!



ATION BW
INNOV 2008

INNOVATION AWARD OF THE STATE OF BADEN-WÜRTTEMBERG



Resistance spot welding machine

The InvertaSpot GT-C AUTOMATIC is suitable for high and ultra high strength steels. It detects the conditions at the joining point, sets parameters automatically and monitors the welding process. Due to the full automation, it is extremely energy-efficient. Experts can still use the manual mode if necessary and set the parameters freely.

TESTED AND
RECOMMENDED BY

ACURA
BMW
BUICK
CADILLAC
CHEVROLET
CITROËN
DACIA
FERRARI
FORD
GM
GMC
HONDA
HYUNDAI
JAGUAR LAND ROVER
KIA
MAYBACH
MAZDA
MERCEDES-BENZ
MINI
OPEL
PEUGEOT
RENAULT
ROLLS-ROYCE
SMART
TESLA
VAUXHALL

InvertaSpot GT
A U T O M A T I C

InvertaSpot GT AUTOMATIC

Mains voltage

Item no. 471002

3 × 400 V

Item no. 473002

3 × 200-240 V

Scope of delivery:

1 × C-transformer gun 3 m	1 × 474250 set of allen key (4 + 5 mm)
1 × C-arm N° 1	1 × 497096 electrode cap A 32
1 × 474005 balancer bar streight	1 × 474028 Lateral hanger for C-arms
1 × 474013 balancer gibbet	1 × 478085 Holder for cable package
1 × 478060 balancer roller (cpl.)	1 × 478041 Suspension hook for power cable
1 × 498085 spring balancer	1 × 474007 Wheel set incl. screws
1 × 474017 insulation strap	1 × Instruction manual





**SAVING OF INDIVIDUAL
WELDING PARAMETERS**

**DOCUMENTING AND
MANAGING OF JOB
DATA**

**MATERIAL
RECOGNITION**

SOFTWARE UPDATES

**CURRENT CONTROL
AND PRESSURE
MONITORING**



- Energy-efficient**
- Time saving**
- Software updates**
- Best service**
- Local support**

Resistance spot welder

The VAS 6545A resistance spot welder can be used to carry out all approved repair welds on Volkswagen Group vehicles. The welding parameters are set using simple, self-explanatory symbols. The welding programmes are for high-strength and ultra high-strength sheet metal, for adhesive spot-welded joints and for galvanised sheet metal.

VAS 6545A

VAS 6545A	ASE Number	Mains voltage
Item no. 932160	ASE 437 075 01 000	3 x 400 V
Item no. 932161	ASE 437 075 00 023	3 x 200-240 V

Accessory set 7 pieces

VAS 6545A/1	ASE Nummer
Item no. 932110	ASE 437 075 01 000

Accessory set for the resistance spot welder VAS 6545A for device protection and for extending the application range of spot welding.

- Scope of delivery:
- 1 x Cover for InvertaSpot GT
 - 1 x Raising & wheel spacer set
 - 1 x Electrode set N° 7 for C-arm N° 1 cap size 16; 90°
 - 1 x C-arm N° 4 with electrode 260 mm; cap size 16
 - 1 x Electrode 170 mm, for C-arm N° 4 cap size 16
 - 1 x Electrode cap remover
 - 1 x Abrasive sponge grain 60



- Scope of delivery:
- 1 x Control unit with water tank 80 l
 - 1 x C-trafogun 3 m
 - 1 x C-arm N° 1
 - 1 x C-arm set N° 3 + E-set 90°
 - 1 x Suspension unit with spring balancer
 - 1 x Hanger for C-arms
 - 1 x Instruction manual



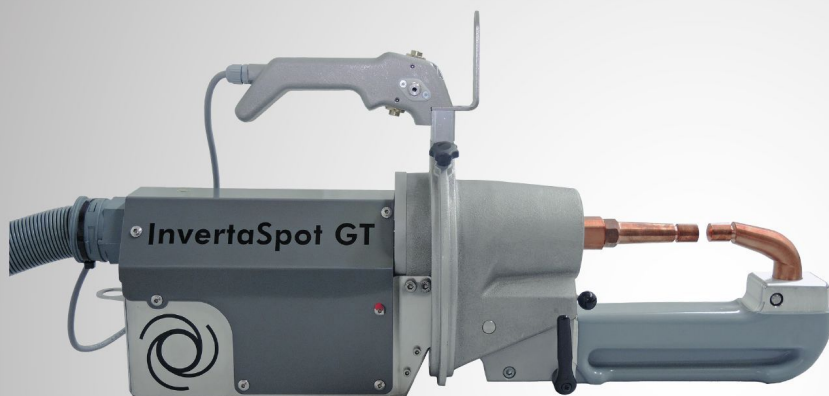

AUTOMATIC FUNCTION

PROCESS CONTROL

ELECTRONIC DISTANCE MEASUREMENT

WATER COOLING UP TO THE ELECTRODE CAPS

LARGE OPENING ANGLE

The transformer gun was developed under strict EN standards and corresponds to the latest technological state of safety. The electrode lock with water stop when changing the arms provides additional safety and comfort.

With the numerous electrode arms and the extensive range of accessories, no wishes are left unfulfilled - but special designs are also possible on request.

C-TRAFOGUN GT-V6

C-TrafoGUN GT-V6

Item no. 474466

Scope of delivery:

- 1 x C-trafogun 3 m
- 1 x C-arm N° 1
- 1 x Electrode caps I type A-32
- 1 x Suspension hook
- 1 x Rotation ring



Cable bundle length	L x W x H	Weight	Adjustment range	Welding current	Electrode pressure	Mark of conformity
Standard: 3 m up to 6 m possible	600 x 100 x 320 mm	15 kg	0-13 kVA	max. 13 kA	max. 6.2 N	CE/UL/CCC depending on version

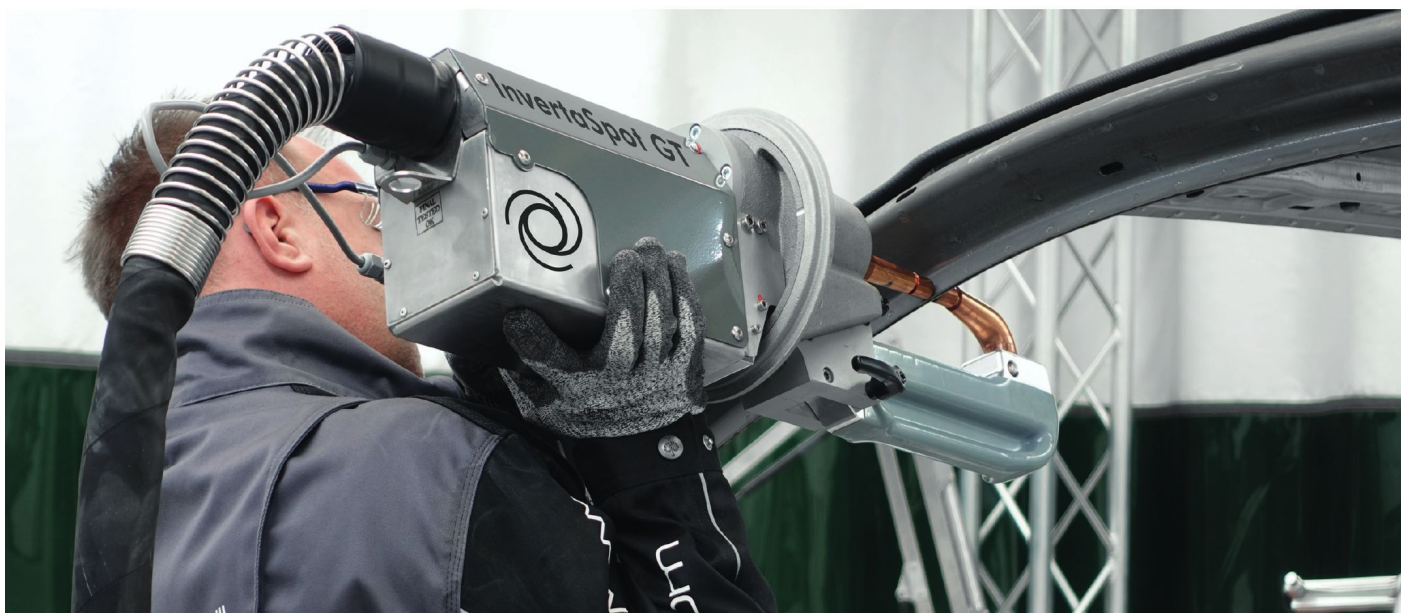

C-Arm N° 1 | standard

Item no. 495620

Electrodes	Electrode caps
C-electrode curved	Ø 16 mm

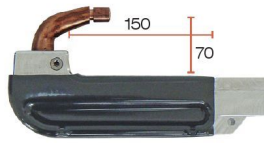

C-Arm N° 3

Item no. 495625

Electrodes	Electrode caps
C-Electrode curved	Ø 16 mm

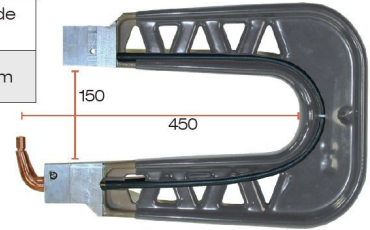

C-Arm N° 2 | for wheel arches

Item no. 495602

Electrodes	Electrode caps
Electrode A Mushroom shape Electrode B Spoon shape	Ø 13 mm

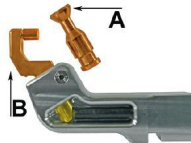

C-Arm N° 4

Item no. 495615

Electrodes	Electrode caps
Electrode 260 mm Electrode holder	Ø 16 mm

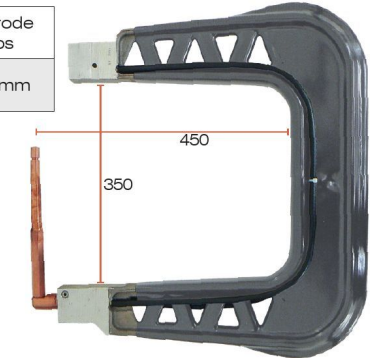

Shape A | Mushroom

Item no. 497070

QTY: 1 pc.



Shape B | Spoon

Item no. 497072

QTY: 1 pc.



A | R32

Item no. 497005

QTY: 6 pc.



C-Arm N° 5

Item no. 495626

Electrodes	Electrode caps
C-Electrode curved Electrode 135 mm Copper sealing washer	Ø 16 mm

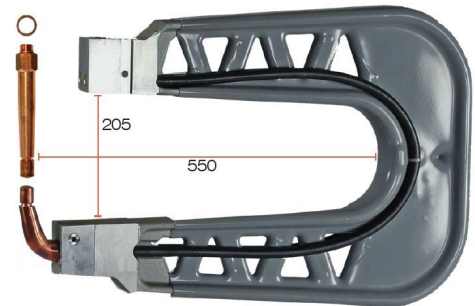
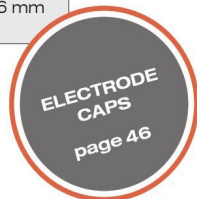

C-Arm N° 6

Item no. 495611

Electrodes	Electrode caps
Electrode 46 mm Electrode holder	Ø 16 mm

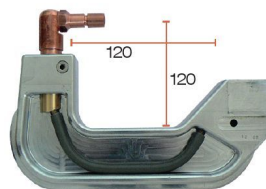

C-Arm N° 7

Item no. 495650

Electrodes	Electrode caps
Electrode 83 mm Electrode holder	Ø 16 mm

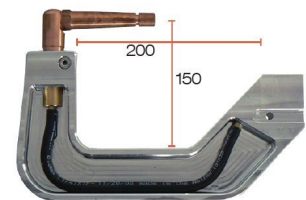

C-Arm Set | C-Arm N° 2 + N° 3

Item no. 495630

Electrodes	Electrode caps
C-Electrode curved Electrode A Mushroom shape Electrode B Spoon shape	Ø 16 mm

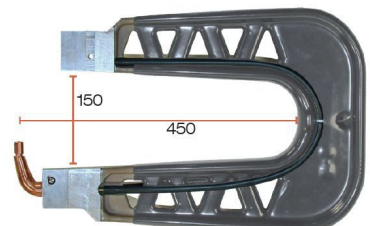
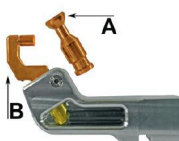

C-Arm Electrode attachment with rocker „Passat“

Item no. 495664

For C-arm N° 1

Electrode set with rocker for welding very narrow strips of sheet metal, e.g. on the VW Passat. Due to the concentric electrodes, which move the welding spot from the centre to the outside, you can reach every corner.

Full functionality of the automatic mode guaranteed.

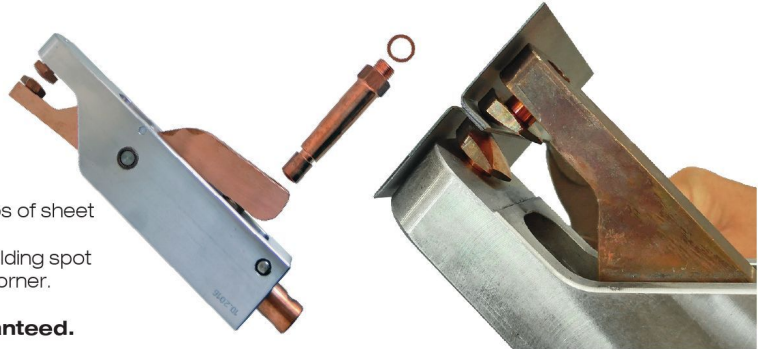

Electrodes hexagonal

Item no. 495669

QTY: 2 pcs.

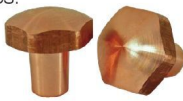

Electrodes concentric

Item no. 495679

QTY: 2 pcs.



Electrode straight | 101.5 mm

Item no. 495673



C-Arm Electrode attachment with rocker N° 10 | for wheel arches

Item no. 495604

For C-arm N° 1

Electrode set with rocker for easier welding of wheel arches. For all repair/welding tasks where there is no accessibility with conventional electrodes.

Full functionality of the automatic mode guaranteed.



Electrode flat

Item no. 495659



Electrode F | finger shape

Item no. 497073



Electrode Set N° 7 | 90° angle

Item no. 495607

For C-Arm N° 1

Electrodes	Electrode caps
Electrode 149 mm curved Electrode short curved Electrode holder	Ø 16 mm



Electrode 149 mm | curved

Item no. 495676



Electrode short | curved

Item no. 495695



Electrode Set N° 9 | 38° angle

Item no. 495645

For C-Arm N° 1

Electrodes	Electrode caps
Electrode bent 38° long Electrode bent 38° short Electrode holder	Ø 16 mm



Electrode Set N° 12 | 38° angle

Item no. 495646

For C-Arm N° 1

Electrodes	Electrode caps
Electrode bent 38° long Electrode bent 38° short	Ø 16 mm



Electrode bent 38° | long

Item no. 495677



Electrode holder for Set N° 7 & N° 9

Item no. 495627



Screw bolt for electrode set N° 7

Item no. 495693



O-rings for screw bolt

Item no. 495694

QTY: 3 pcs.



Electrode Set N° 11 | 90° angle

Item no. 495606

For C-Arm N° 1

Electrodes	Electrode caps
Electrode 121 mm Electrode 28 mm	Ø 16 mm



Electrode 28 mm

Item no. 495623











Electrode 121 mm

Item no. 495622



Electrodes

Length	Shape	Suitable for C-Arm							Item no.
		N° 1	N° 2	N° 3	N° 4	N° 5	N° 6	N° 7	
46 mm	straight 						•		495621
83 mm	straight <i>Standard electrode on gun side</i> 				•			•	495617
135	straight 					•			495667
170	straight 				•				495619
260	straight 				•				495616
	c-shape curved 	•		•		•			495635
	Shape A Mushroom 		•						497070
	Shape B Spoon 		•						497072

Electrode Set for C-Arm N° 4

Item no. 495618

QTY: 2 pcs.



Electrode holder

Item no. 495692

suitable for:

- C-Arm N° 4
- C-Arm N° 6
- C-Arm N° 7



Copper sealing washers M16

Item no. 494040

QTY: 2 pcs.



Electrode caps

Electrode Caps

Ø 13 mm

Type	F round	Spade shape long	A R32	straight	straight	sloped R20	E	D
Length	18 mm	23 mm	18 mm	19.5 mm	24 mm	16.5 mm	18 mm	18 mm
Suitable for					X-gun E-Set no. 74	X-gun E-Set no. 70		
QTY	6 pcs.	6 pcs.	6 pcs.	6 pcs.	6 pcs.	6 pcs.	4 pcs.	4 pcs.
Item no.	497001	497004	497005	497006	497007	497008	497016	497018



	Ø 12 mm	Ø 12 mm					
Type	ball	sloped			round	short	
Length	18 mm	18 mm			18.5 mm	16 mm	
Suitable for	Multi Spot 297106	Multi Spot			X-gun E-Set no. 72	X-gun E-Set no. 73	
QTY	6 pcs.	6 pcs.			3 pcs.	3 pcs.	
Item no.	297121	297122			497086	497009	



Ø 16 mm

Type	A-32	B conical-flat	H Spade shape	E	A-40 R 40	D conical-flat	F round	P eccentric	D 38°
Length	20 mm	20 mm		20 mm	20 mm		20 mm	20 mm	24 mm
Suitable for	C-Trafogun AUTOMATIC		Warning! X-gun only						E-Set no. 9 (495645) E-Set no. 12 (495646)
QTY	6 pcs.	4 pcs.	6 pcs.	4 pcs.	6 pcs.	4 pcs.	4 pcs.	4 pcs.	6 pcs.
Item no.	497096	497079	497020	497081	497097	497085	497075	497076	497105



Electrode Cap Set

Item no. 497102

Scope of delivery:
2 × Electrode cap type B (497079)
2 × electrode cap type H (497020)



Electrode caps assortment | Ø 16 mm | C-Trafogun

Item no. 497110

Scope of delivery:
1 × Assortment box
2 × Electrode cap type **A-40**
4 × Electrode cap type **B**
2 × Electrode cap type **E**
2 × Electrode cap type **A-32**
2 × Electrode cap type **H**
2 × Electrode cap type **D**
2 × Electrode cap type **P**

